

LINDY®

CONNECTION PERFECTION

Modular Matrix Range

User Manual

English



No. 38250, 38251, 38252, 38253, 38254, 38255,
38256, 38257, 38259

www.lindy.com



Tested to Comply with
FCC Standards
For Home and Office Use!

© LINDY ELECTRONICS LIMITED & LINDY-ELEKTRONIK GMBH - FIRST EDITION (April 2015)

Introduction

Thank you for purchasing from the LINDY Modular Matrix range of products. This range of products is designed to allow you to create a matrix with 8, 16 or 32 input and output ports. The input ports can be a choice of C6 HDBaseT, HDMI, DVI or VGA while the output ports can be HDMI, DVI or C6 HDBaseT. Any of the inputs can be combined with any of the outputs to create a UHD 4Kx2K@30Hz display over distances of up to 70m and 1080p up to 100m. The modular design provides the ultimate in flexibility for audio and video distribution as a matrix, convertor or an extender in retail product demonstration, training and public display application in schools, pubs etc.

Package Contents

- Modular Matrix (including control board) with spaces for 2, 4 or 8 modular boards
- IR Blaster
- Blanking plates fitted to the rear of the units
- IR Extender
- Power Cord (2x for 16 and 32 port Chassis)
- Remote control inc battery
- User manual

- Input boards – choose from C6 HDBaseT, HDMI, DVI-D and VGA
- Output boards – choose from HDMI, DVI-D and C6 HDBaseT

Features

Modular Chassis

- Supports HDMI 4K, C6 HDMI Extender 4K, VGA WUXGA and DVI 1080p resolutions
- Modular input and output boards can be mixed between multiple interfaces
- Supports Audio pass-through on all boards
- Supports RS232, Telnet and Web GUI controls
- Supports multiple EDID modes
- 16 & 32 port models have redundant power supplies
- Rack Mountable

Installation

Your modular matrix may need some assembly, before installing the modular boards please ensure you have taken the appropriate steps to avoid static discharge. Assembly should only be attempted by a qualified person and the chassis should not be connected to the power when adding the boards. The boards are not hot pluggable and if further boards are to be added, the unit must be powered down and unplugged.

Make sure all your devices are switched off before making any connections. Once all the connections are made, switch on the devices in this order: displays, Matrix, source devices.

Operation

Front Panel – 8x8 Version

1. **Power Button & LED:** Press this button to turn the Matrix on, press it again to put it in standby mode. The LED will illuminate red in standby mode. If the LED is flashing then the internal temperature is too high and the Matrix needs ventilation.
-

2. **LCM:** Displays the status of each input and output plus options available when in Menu mode.
3. **Lock Button & LED:** Press this button to lock all the function buttons on the panel, press and hold it again to unlock the buttons. The LED will illuminate red when the buttons are locked.
4. **Return:** Press this button while in Menu mode and you will be taken back a step.
5. **Menu:** Press this button to enter the Menu:
 1. **EDID:**
 - a. Standard EDID: use the built in EDID which supports video up to 1080p@60Hz / WUXGA@60RB and Audio LPCM 2CH.
 - b. Dynamic EDID: Copies the first connected output device EDID.
 - c. Manual EDID: Uses the EDID of each device connected to the input / output ports.
 2. **IP:**
 - a. IP address
 - b. Netmask
 - c. Gateway
 3. **Temperature:**
 - a. Temperature 1
 - b. Temperature 2, shows the internal temperature of the device.
 4. **LCM Contrast range from 1-4**
6. **Left/Right Arrows:** Use these buttons to scroll through the pages while in the menu mode.
7. **Save:** Press this button to save the current setting of the Input / output ports (8 positions available).
8. **Recall:** This button will allow you to recall the saved pre-sets.
9. **Enter:** Press this button to confirm the setting or selection.
10. **All:** Press all, then the input port then enter to display the same signal on all ports.
11. **Out/In:** Use these buttons to select the input source you want to show on an output/display. The sequence should be to select the output ports (display) from the top row of buttons, then select the input source device.
12. **1-8:** The numbers relate to the input and output ports on the rear of the unit.

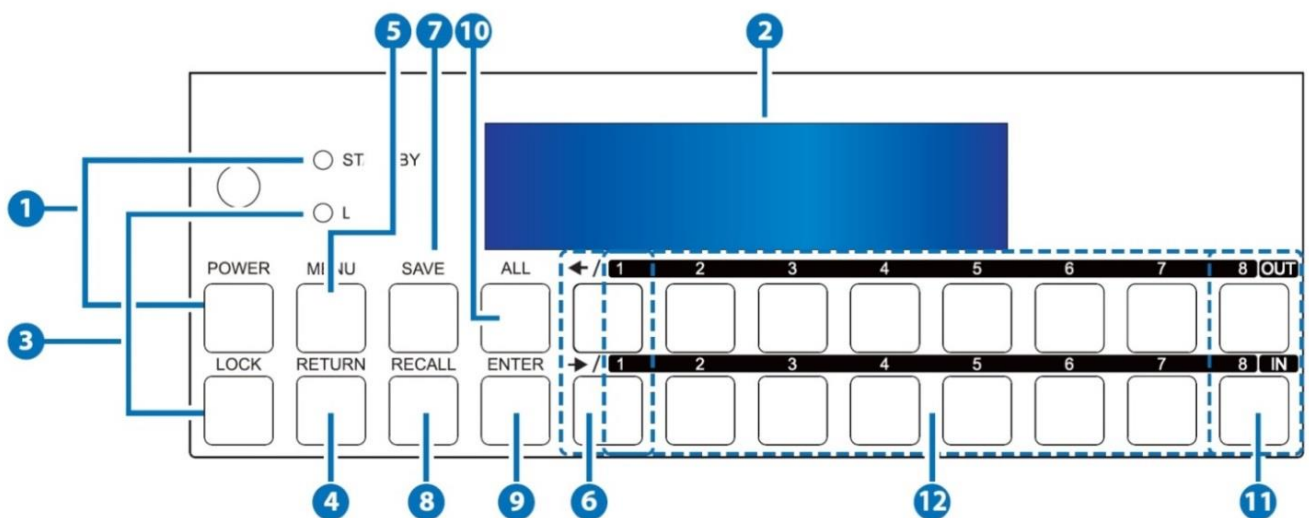

Rear Panel

Note: the example below shows an 8x8 matrix fitted with HDMI input and HDMI output boards.

1. **Output 1-8:** Connect your display devices to the output ports.
2. **Central CPU Board:** (with the following connections)
 - a. IR In: Extend your IR receiver port using the included IR receiver.

- b. RS-232: Connect a D-Sub 9 pin cable from a PC/Laptop for RS232 control of the Matrix or connected devices.
 - c. Control: Connect an active network cable for Telnet/Web GUI control.
 - d. IR All Out/In: Reserved.
 - e. Service: This port is reserved for firmware update only.
 - f. Output 0: This port is not activated.
3. **Input 1-8:** Connect your source devices to the input ports on the lower part of the unit.
 4. **Power:** The device will automatically turn on when the power cable is connected.
 5. **Ventilation fan:** The fan will be active when the device is switched on. The vent must not be blocked or covered and must have adequate space to allow ventilation.

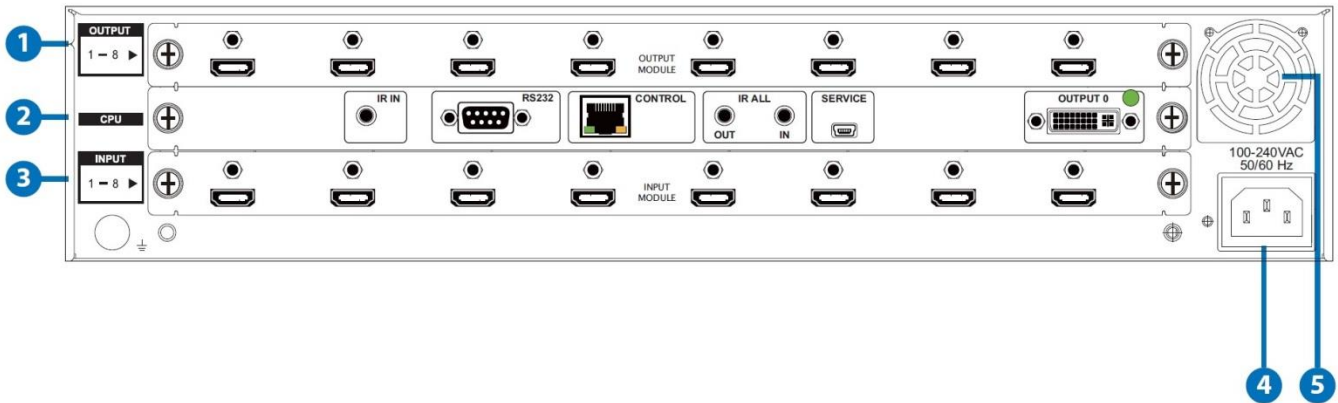

Front Panel – 16x16 Version

1. **LCM:** Displays the status of each input and output plus options available when in Menu mode.
2. **IR Window:** Receives the signal from your infrared remote control
3. **Power Button & LED:** Press this button to turn the Matrix on, press it again to put it in standby mode. The LED will illuminate red in standby mode. If the LED is flashing then the internal temperature is too high and the Matrix needs ventilation.
4. **Left/Right/Up/Down Arrows:** Use these buttons to scroll through the pages while in the menu mode.
5. **Return:** Press this button while in Menu mode and you will be taken back a step.
6. **Menu:** Press this button to enter the Menu:
 1. **EDID:**
 - a. Standard EDID: use the built in EDID which supports video up to 1080p@60Hz / WUXGA@60RB and Audio LPCM 2CH.
 - b. Dynamic EDID: Copies the first connected output device EDID.
 - c. Manual EDID: Uses the EDID of each device connected to the input / output ports.
 2. **IP:**
 - a. IP address
 - b. Netmask
 - c. Gateway
 3. **Temperature:**
 - Shows the internal temperature of the device.
 5. **LCM Contrast range from 1-4**
 - Adjust the LCM contrast from 1 to 4
7. **All:** Press this button to assign the same input to all outputs
8. **Out/In:** Use these buttons to select the input source you want to show on an output/display. The sequence should be to select the out/in button then the input, then the out/in and then the output, finally select enter.
9. **1-9:** The numbers relate to the input and output ports on the rear of the unit.

10. **Plus (+):** This allows you to select multiple outputs for a selected input and can only be used in conjunction with the OUT/IN button.
11. **Lock Button & LED:** Press this button to lock all the function buttons on the panel, press and hold it again to unlock the buttons. The LED will illuminate red when the buttons are locked.
12. **Save:** Press this button to save the current setting of the Input / output ports (8 positions available).
13. **Recall:** This button will allow you to recall the saved pre-sets.
14. **Enter:** Press this button to confirm the setting or selection.

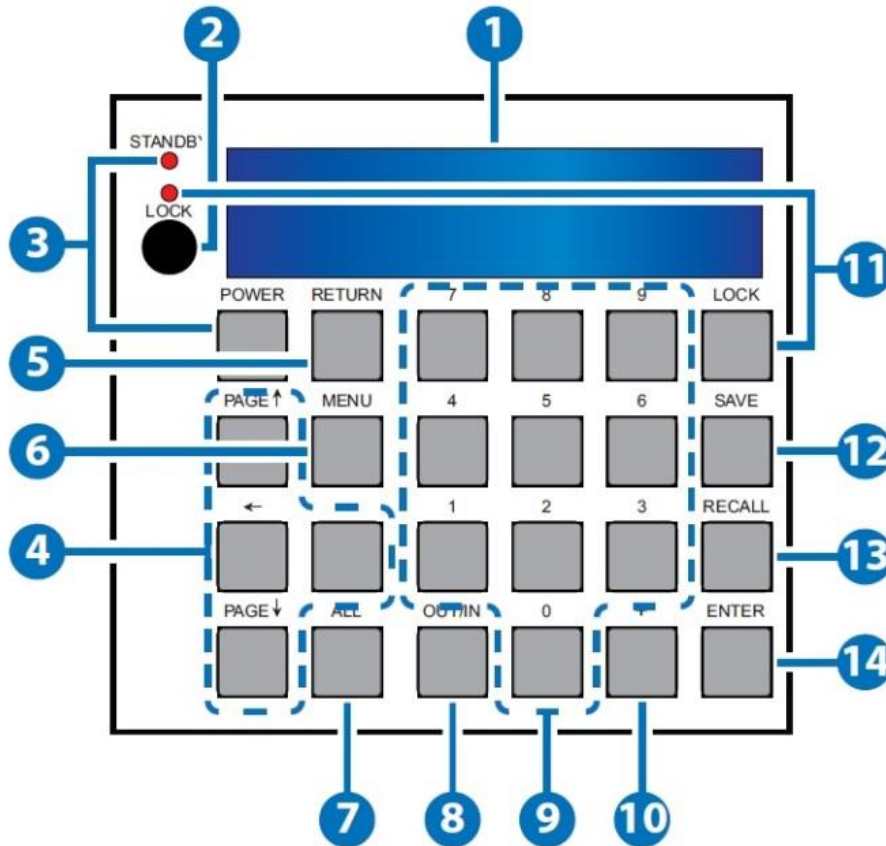

Rear Panel

Note: the example below shows a 16x16 matrix fitted with HDMI input and HDMI output boards.

1. **Output 1-16:** Connect your display devices to the output ports.
2. **Central CPU Board:** (with the following connections)
 - a. IR In: Extend your IR receiver port using the included IR receiver.
 - b. RS-232: Connect a D-Sub 9 pin cable from a PC/Laptop for RS232 control of the Matrix or connected devices.
 - c. Control: Connect an active network cable for Telnet/Web GUI control.
 - d. IR All Out/In: Reserved.
 - e. Service: This port is reserved for firmware update only.
 - f. Output 0: This port is not activated.
3. **Input 1-16:** Connect your source devices to the input ports on the lower part of the unit.
4. **Power:** The device will automatically turn on when the power cable is connected.
5. **Ventilation fan:** The fan will be active when the device is switched on. The vent must not be blocked or covered and must have adequate space to allow ventilation.

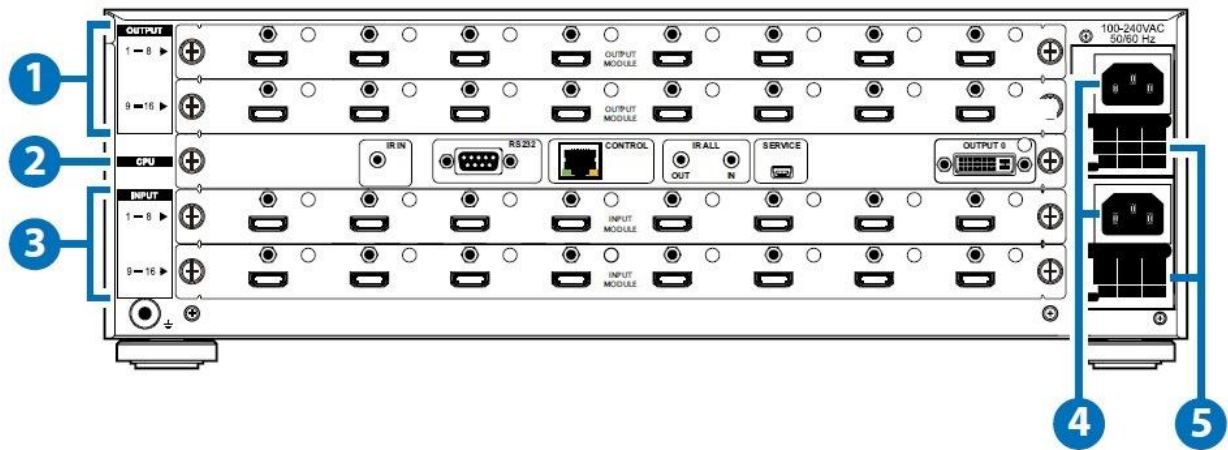

Front Panel – 16x16 Version

1. **LCM:** Displays the status of each input and output plus options available when in Menu mode.
2. **Power Button & LED:** Press this button to turn the Matrix on, press it again to put it in standby mode. The LED will illuminate red in standby mode. If the LED is flashing then the internal temperature is too high and the Matrix needs ventilation.
3. **Return:** Press this button while in Menu mode and you will be taken back a step.
4. **Left/Right/Up/Down Arrows:** Use these buttons to scroll through the pages while in the menu mode.
5. **Menu:** Press this button to enter the Menu:
 1. **EDID:**
 - a. Standard EDID: use the built in EDID which supports video up to 1080p@60Hz / WUXGA@60RB and Audio LPCM 2CH.
 - b. Dynamic EDID: Copies the first connected output device EDID.
 - c. Manual EDID: Uses the EDID of each device connected to the input / output ports.
 2. **IP:**
 - a. IP address
 - d. Netmask
 - e. Gateway
 3. **Temperature:**

Shows the internal temperature of the device
6. **LCM Contrast range from 1-4**

Adjust the LCM contrast from 1 to 4
6. **All:** Press this button to assign the same input to all outputs
7. **1-9:** The numbers relate to the input and output ports on the rear of the unit.
8. **Out/In:** Use these buttons to select the input source you want to show on an output/display. The sequence should be to select the out/in button then the input, then the out/in and then the output, finally select enter.
9. **Plus (+):** This allows you to select multiple outputs for a selected input and can only be used in conjunction with the OUT/IN button.
10. **Lock Button & LED:** Press this button to lock all the function buttons on the panel, press and hold it again to unlock the buttons. The LED will illuminate red when the buttons are locked.
11. **Save:** Press this button to save the current setting of the Input / output ports (8 positions available).
12. **Recall:** This button will allow you to recall the saved pre-sets.
13. **Enter:** Press this button to confirm the setting or selection

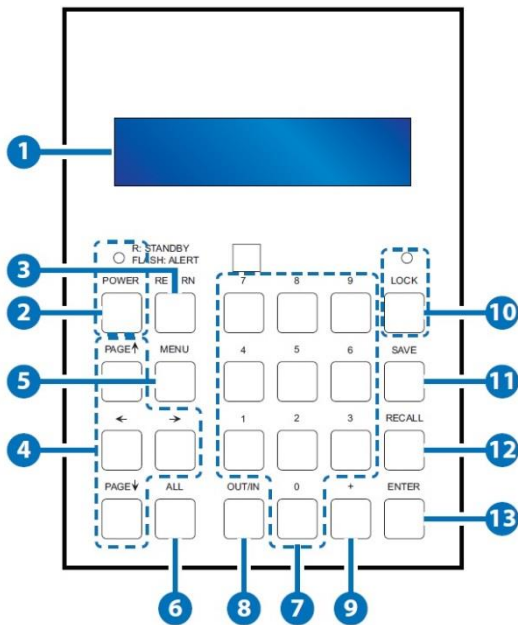

Rear Panel

Note: the example below shows a 32x32 matrix fitted with HDMI input and HDMI output boards.

1. **Output 1-32:** Connect your display devices to the output ports.
2. **Central CPU Board:** (with the following connections)
 - a. IR In: Extend your IR receiver port using the included IR receiver.
 - b. RS-232: Connect a D-Sub 9 pin cable from a PC/Laptop for RS232 control of the Matrix or connected devices.
 - c. Control: Connect an active network cable for Telnet/Web GUI control.
 - d. IR All Out/In: Reserved.
 - e. Service: This port is reserved for firmware update only.
 - f. Output 0: This port is not activated.
3. **Input 1-32:** Connect your source devices to the input ports on the lower part of the unit.
4. **Power:** The device will automatically turn on when the power cable is connected.
5. **Ventilation fan:** The fan will be active when the device is switched on. The vent must not be blocked or covered and must have adequate space to allow ventilation.

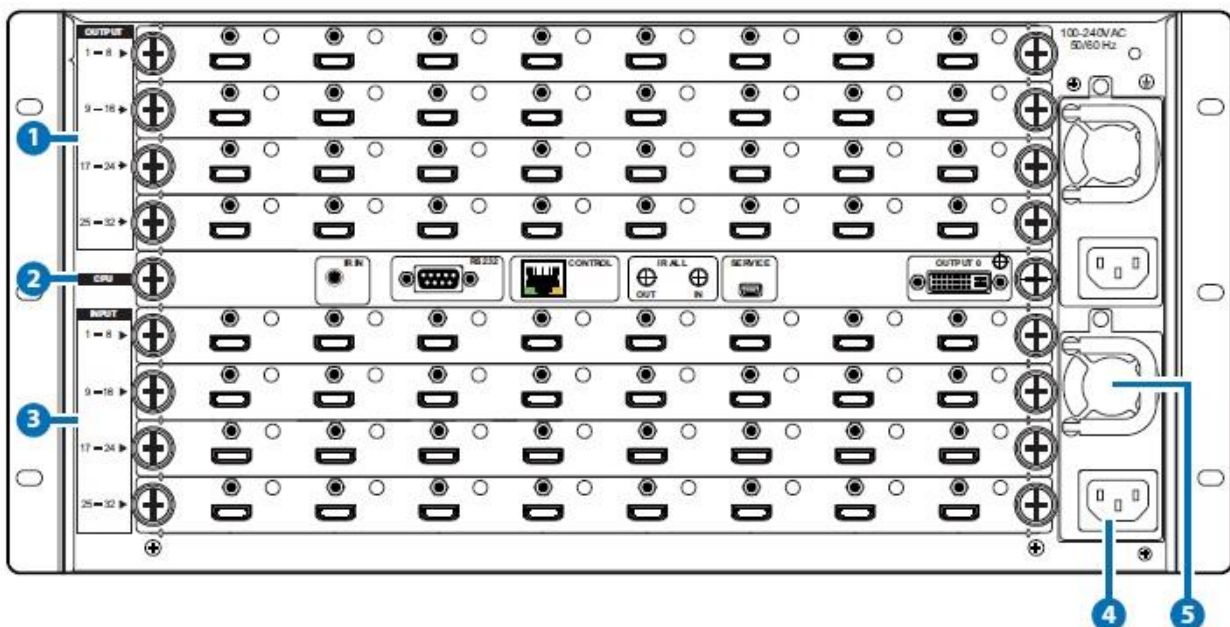

Remote Control

- 1. **Output:** Output port selection
- 2. **Input:** Input port selection
- 3. **Enter:** Press to confirm the present input/output selection
- 4. **Clear:** Press to clear the present input/output selection

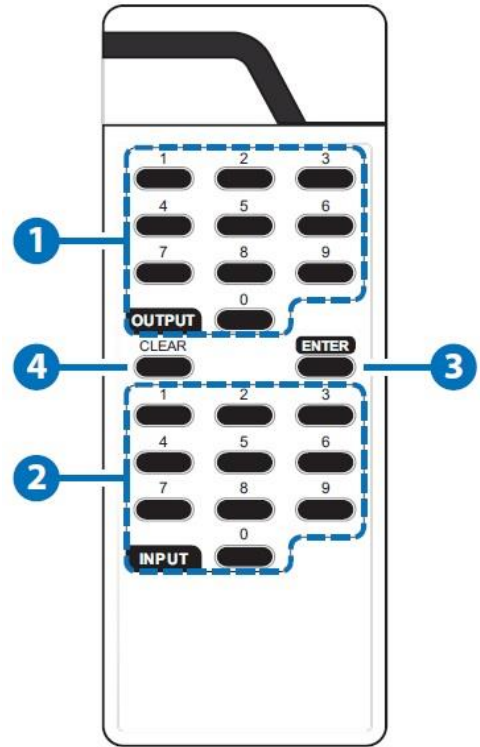

RS-232 Protocols

CMSI-88			Remote Controller	
PIN	Definition		PIN	Definition
1	NC		1	NC
2	TxD	→	2	RxD
3	RxD		3	TxD
4	NC		4	NC
5	GND	←	5	GND
6	NC		6	NC
7	NC		7	NC
8	NC		8	NC
9	NC		9	NC

Baud Rate: 19200bps
Data Bit: 8 Bits
Parity: None
Stop Bit: 1
Flow Control: None

RS-232 & Telnet Command

Command	Description
P1	Power on.
P0	Power off.
Oxly	Output (x:0~8) set to input (y:1~8).
ALLOUT x	All output set to input (x:01~8).
ACTIVE	Report I/O active channels.
INDETECT	Input channels detect indicator.
OUTDETECT	Output channels detect indicator.
PORTSTATUS	Report all output connection status.
HDCPON x	Setting input port(x:01~8) HDCP on.
HDCPOFF x	Setting input port (x:01~8) HDCP off.
HDCPONALL	Setting all input port HDCP on.
HDCPOFFALL	Setting all Input port HDCP off.
HDCPSTATUS	Show HDCP status of all output(0=HDCP disable,1=enable).
MUTEO x	Video mute command at output (x:0~8) interface.
UNMUTEO x	Video unmute command at output (x:0~8) interface.
MUTEI x	Video mute command at input (x:1~8)interface.
UNMUTEI x	Video unmute command at input (x:1~8) interface.
MUTEALL	Mute all outputs.
UNMUTEALL	Unmute all outputs.
MUTESTATUS	Show mute status of all output(0=not muted,1=muted).
HPDL x	Pull the input(x:01~8) Hot-Plug-Detect signal to 'LOW'.

Command	Description
HPDH x	Pull the input(x:01~8) Hot-Plug-Detect signal to 'HIGH'.
HPDLALL	Set all input HPD to Low.
HPDHALL	Set all input HPD to High.
HPDSTATUS	Report all input Hot-Plug-Detect signal status.
EDIDMODE x y	Set EDID mode(y:1~3) to Input(x: 01~8).
EDIDMODEALL x	The EDID mode(x:1~3) of All Input.
EDIDPORT x y	Set EDID Assigned Port(y:01~8) to Input(x:01~8).
EDIDPORTALL x	The EDID of All Inports is assigned to Output (x:01~8).
EDIDSTATUS	Report all input EDID mode&port.
IRMASKOUT x y z*	Set output port board IR mask(x:SINK/SRC, y:1~8/All, z:0/1).
IRMASKCPU x y z*	Set CPU board allout IR mask(x:SINK/SRC/OUT, y:1~8/All, z:0/1)
SHOWIRMASKOUT x y*	Write UART string to output port(x:SINK/SRC, y:1~8/All).
SHOWIRMASKCPU x y*	Show CPU board IR mask status (x:SINK/SRC/OUT, y:1~8/All).
UART x y "str"	Write UART string to output port(x:in/out, y:01~8, str:String).
UARTBAUD x y	Setting output port(x:01~8) UART baud rate(y).
STATUSUART	Show output port UART baud rate.
TEMPSTATUS	Show temperature sensor values y1, y2.
SETIPADDR	Setting IP address<x.x.x.x>.
SETSNMASK	Setting subnet mask<x.x.x.x>.
SETGWADDR	Setting gateway IP address<x.x.x.x>.
IPCONFIG	Display the current IP config.

Command	Description
RSTIP	IP Configuration Was Reset To Factory Defaults(DHCP).
BUZZER x	Buzzer Mute(0),UnMute(1).
REBOOT	System reboot.
SAVETO x	Save as Preset x(1~8).
RECALLTO x	Recall Preset x(1~8).
RESET	System Reset to O1I1,O2I2,O3I3,O4I4,O5I5....
VERSION	Display controller firmware version.

NOTE: All commands are case sensitive and must be followed by a carriage return to be executed

*These commands are for C6 HDBaseT modules only

- SINK = The connected receiver
- SRC= Output port on the module
- ALL= IR all on the CPU board
- 0/1= Off/On

RS-232 Protocols

Before attempting to use telnet control, ensure that both the matrix and the PC/Laptop are connected using an active network.

To access the telnet control in Windows 8, click on the 'start' menu and type 'CMD' and press enter.

When using Windows 7, click on the 'start' menu and type 'CMD' in the search field and press enter.

When using Windows XP, click on the 'Start' menu and click on 'Run', type 'CMD' and then press enter.

When using a Mac, go to 'Go', 'Applications', 'Utilities' and choose 'Terminal'.

Once in the command line interface type 'telnet', then type the IP address of the unit followed by a space and 23, then hit enter.

NOTE: The IP address of the Matrix can be displayed on the device's LCM monitor by pressing the 'Menu' button twice.

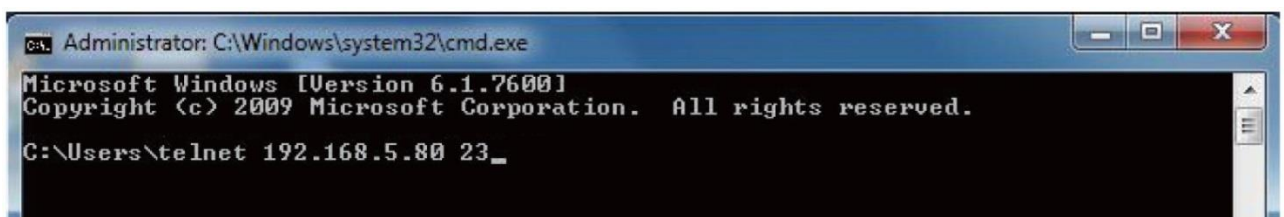

When you have successfully connected to the Matrix type 'HELP' and press enter to see the available list of commands.

```

telnet 192.168.5.139
Welcome to Matrix TELNET.

telnet-> help

      P0 : Power Off
      P1 : Power On
      RESEt : System Reset to 01i1,02I2,03I3,04I4,05I5....
      0xxIxx(x:01~8) : Output 0~8 set to Input 1~8
      ALLOU t xx(x:01~8) : All Output set to Input 1~8
      MUTE xx(x:0~8) : Video mute command at output interface
      UNMUTE xx(x:0~8) : Video unmute command at output interface
      MUTEALL : Mute all outputs
      UNMUTEALL : Unmute all outputs
      SHOWMUTE : Show mute status of all output(0=not muted,1=muted)
      RDMUTE xx(x:0~8) : Read MUTE Status at Output
      HPDLOW xx(x:01~8) : Pull the Hot-Plug-Detect signal to 'LOW'
      HPDHIGH xx(x:01~8) : Pull the Hot-Plug-Detect signal to 'HIGH'
      HPDLOW ALL : Set All Input HPD to Low
      HPDHIGH ALL : Set All Input HPD to High
      SHOWHPD : Report ALL Input Hot-Plug-Detect signal status
      STATUSHPD x(x:1~8) : Show HPD status of input(x)
      SHOWTEMP : Show temperature sensor values y1, y2
      STATUSIN xx(x:01~8) : Report Input connection status
      STATUSOUT xx(x:0~8) : Report Output connection status
      STATUSALL : Report ALL Output connection status
      STATUSEDID : Report ALL Input EDID node&port
      SEIEDIDMODE ii mn(ii:01~8 mn:1~3) : Set EDID mode(mn) to Input(ii)
      SEIEDIDMODE ALL mn (mn=1~3) : The EDID mode(mn) of All Input(ii)
      SETEDIDPORT ii pp(ii:01~8 pp:01~8) : Set EDID Assigned Port(pp) to Input(ii)
      SEIEDIDPORT ALL mn (pp=01-8) : The EDID of All Inports is assigned to Output
      pp
      ACTIUE : Report I/O active channels
      INDETECT : Input channels detect indicator
      OUTDETECT : Output channels detect indicator
      IPCONFIG : Display the current IP config
      SETIP <IP> <SubNet> <GW> : Setting IP.SubNet.GateWay(Static IP)
      RSTIP : IP Configuration Was Reset To Factory Defaults(DHCP)
      SETIPADDR <IP> : Setting IP address
      SETSNMASK <SubNet> : Setting subnet mask
      SETGWADDR <GW> : Setting gateway IP address
      R
  
```

Type 'IPCONFIG' to show all IP configurations.

To reset the IP, type 'RSTIP'

To use a static IP, type 'SETIP'

The full list of commands are in the previous section.

Web GUI Control

To access the Web GUI, open a web browser and type the devices IP address. The browser will display the devices status, control and user setting pages.

Status	Control	User Setting
--------	---------	--------------

Power Status

Power Status: ON

IP Status

IP Address:	192.168.5.135
NetMask Address:	255.255.255.0
GateWay Address:	192.168.5.254
MAC Address:	0E-12-00-EA-7A-F1
Http Port Number:	80
Telnet Port Number:	23

Matrix Status

OutPut Port 01: InPut Port 1	OutPut Port 02: InPut Port 2	OutPut Port 03: InPut Port 3	OutPut Port 04: InPut Port 4
OutPut Port 05: InPut Port 5	OutPut Port 06: InPut Port 6	OutPut Port 07: InPut Port 7	OutPut Port 08: InPut Port 8

Click on the 'Control' tab to control power, input/output ports, EDID & Reset mode.

Status	Control	User Setting
--------	---------	--------------

Power Control

PowerON

Matrix Control

OutPut Port 1: <input type="button" value="Input Port 1"/>	OutPut Port 2: <input type="button" value="Input Port 2"/>	OutPut Port 3: <input type="button" value="Input Port 3"/>	OutPut Port 4: <input type="button" value="Input Port 4"/>
OutPut Port 5: <input type="button" value="Input Port 5"/>	OutPut Port 6: <input type="button" value="Input Port 6"/>	OutPut Port 7: <input type="button" value="Input Port 7"/>	OutPut Port 8: <input type="button" value="Input Port 8"/>

All OutPut Set To:

System Reset

Click on the 'User Setting' tab to reset the IP configuration. The system will require a reboot of the device every time any of the settings are changed. The IP address on the address bar will need to be updated if this is changed in 'User Setting' tab.

Status	Control	User Setting
--------	---------	--------------

Address Selection

Address Type:	DHCP/AutoIP ▼			
Static IP Address:	192	168	5	135
Subnet Mask:	255	255	255	0
Default Gateway:	192	168	5	254
<input type="button" value="Update Settings"/>				

Connection Diagram

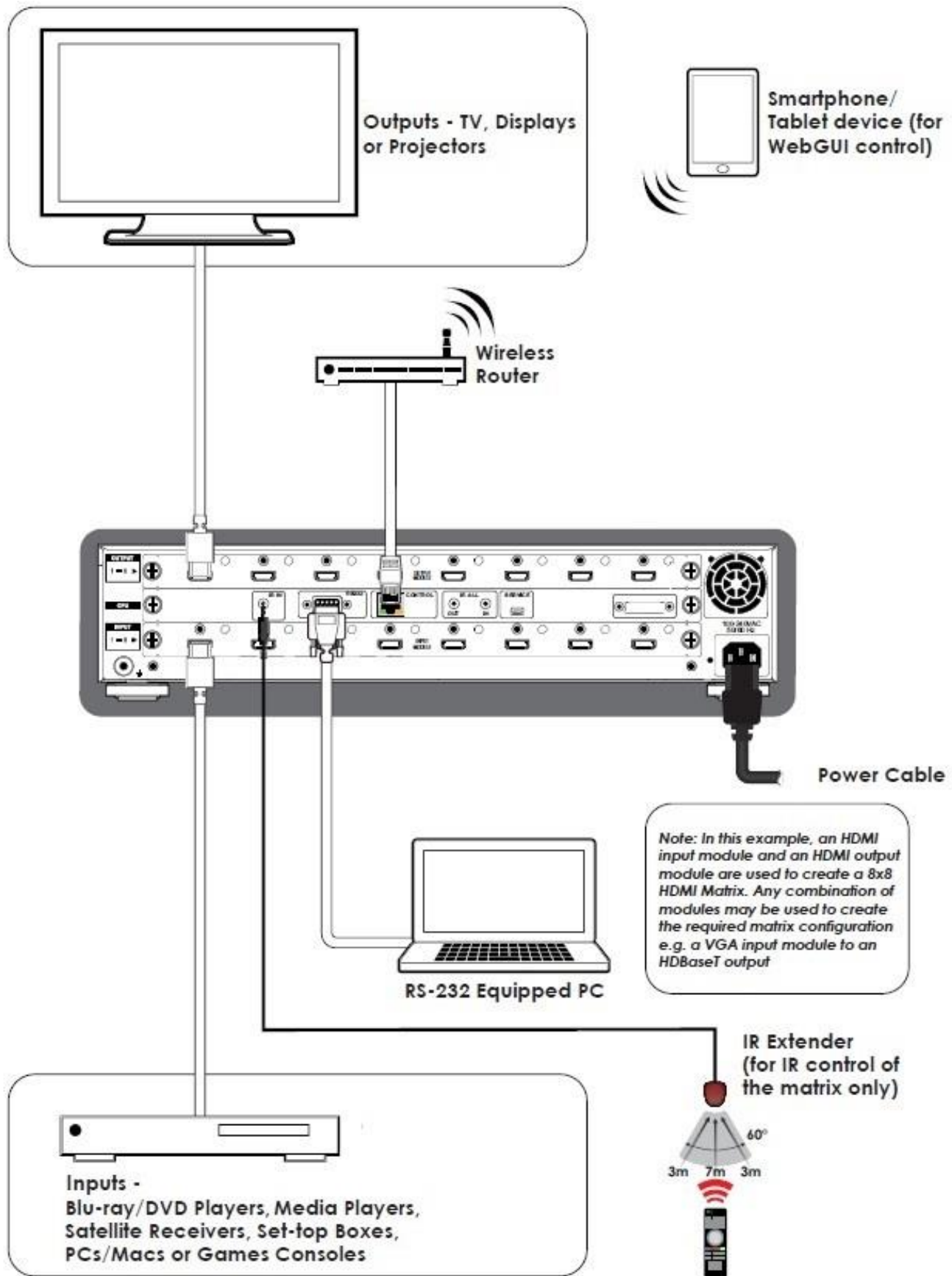

Example shows the 8x8 version





Modules

The following modules are available for this range of products.

Output Modules

-  - 38259
4K2K HDBaseT output module
-  - 38254
4K2K HDMI output module
-  - 38256
DVI output module

Input Modules

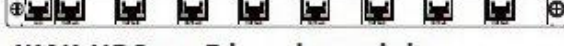
-  - 38257
VGA input module
-  - 38255
DVI input module
-  - 38253
4K2K HDMI input module
-  - 38258
4K2K HDBaseT input module

Output Modules:

C6 using HDBaseT technology - 38259

- Video Bandwidth: 300Mhz / 10.2Gbps
- Features: Audio, Video, PoH (Power over HDBaseT), IR, RS232 & Ethernet
- Output Ports: 8 x RJ45 Shielded Female C6, 8 x IR Extender, 8 x IR Receiver & 1 x RJ45 Network ports
- Ethernet Speed: 100Mbps
- Video Resolutions: PC: VGA-WUXGA / HD: 480i-1080p & 4Kx2K@30Hz
- Audio Transmission: LPCM7.1CH, Dolby TrueHD, Dolby Digital Plus, DTS-HD Master Audio (32-192KHz sample rate)
- Power Consumption: 45W+PoH / Module (10W/port)

Cable Type	Range	Pixel Clock Rate	Video Data Rate	Supported Video
CAT5e/6/7	100m	<225 MHz	<5.3 Gbps	Up to 1080p60Hz*
	70m	>225 MHz	>5.3 Gbps (Ultra HD Video)	4K2K@30Hz

* Data rates lower than 5.3 Gbps or below 225MHz TMDS clock

HDMI - 38254

Video Bandwidth: 300Mhz / 10.2Gbps
Output Ports: HDMI Type A Female
Video Resolutions: PC: VGA-WUXGA / HD: 480i-1080p & 4Kx2K@30Hz
Audio Transmission: LPCM7.1CH, Dolby TrueHD, Dolby Digital Plus, DTS-HD Master Audio (32-192KHz sample rate)
Cable Lengths: Maximum distance, 15m using LINDY CROMO cable
Power Consumption: 22W

DVI - 38256

Video Bandwidth: 225Mhz / 6.75Gbps
Output Ports: DVI Female
Video Resolutions: PC: VGA-WUXGA@60RB / HD: 480i-1080p
Audio Transmission: LPCM7.1CH, Dolby TrueHD, Dolby Digital Plus, DTS-HD Master Audio (32-192KHz sample rate)
Cable Lengths: Maximum distance, 15m using LINDY Premium SLD cable
Power Consumption: 20W

Input Modules:**HDMI - 38253**

Video Bandwidth: 300Mhz / 10.2Gbps
Input Ports: HDMI Type A Female
Video Resolutions: PC: VGA-WUXGA / HD: 480i-1080p & 4Kx2K@30Hz
Audio Transmission: LPCM7.1CH, Dolby TrueHD, Dolby Digital Plus, DTS-HD Master Audio (32-192KHz sample rate)
Cable Lengths: Maximum distance, 15m using LINDY CROMO cable
Power Consumption: 22W

DVI - 38255

Video Bandwidth: 225Mhz / 6.75Gbps
Input Ports: DVI Female
Video Resolutions: PC: VGA-WUXGA@60RB / HD: 480i-1080p
Audio Transmission: LPCM7.1CH, Dolby TrueHD, Dolby Digital Plus, DTS-HD Master Audio (32-192KHz sample rate)
Cable Lengths: Maximum distance, 15m using LINDY Premium SLD cable
Power Consumption: 20W

VGA - 38257

Input Ports: VGA Female & 2.5mm jack (includes 8 x 2.5mm to 3.5mm adapters)
Video Resolutions: PC: VGA-WUXGA@60RB
Audio Transmission: Stereo
Cable Lengths: Maximum distance, 15m using LINDY Premium VGA cable
Power Consumption: 22W

C6 using HDBaseT technology - 38258

Video Bandwidth: 300Mhz / 10.2Gbps
Features: Audio, Video, POH, IR, RS232 & Ethernet
Output Ports: 8 x RJ45 Shielded Female C6 & 1 x RJ45 Network ports

Ethernet Speed: 100Mbps
Video Resolutions: PC: VGA-WUXGA / HD: 480i-1080p & 4Kx2K@30Hz
Audio Transmission: LPCM7.1CH, Dolby TrueHD, Dolby Digital Plus, DTS-HD Master Audio (32-192KHz sample rate)
Power Consumption: 45W

Cable Type	Range	Pixel Clock Rate	Video Data Rate	Supported Video
CAT5e/6/7	100m	<225 MHz	<5.3 Gbps	Up to 1080p60Hz*
	70m	>225 MHz	>5.3 Gbps (Ultra HD Video)	4K2K@30Hz

CE/FCC Statement

CE Certification

This equipment complies with the requirements relating to Electromagnetic Compatibility Standards EN55022/EN55024 and the further standards cited therein. It must be used with shielded cables only. It has been manufactured under the scope of RoHS compliance.

CE Konformitätserklärung

Dieses Produkt entspricht den einschlägigen EMV Richtlinien der EU für IT-Equipment und darf nur zusammen mit abgeschirmten Kabeln verwendet werden.

Diese Geräte wurden unter Berücksichtigung der RoHS Vorgaben hergestellt.

Die formelle Konformitätserklärung können wir Ihnen auf Anforderung zur Verfügung stellen

FCC Certification

This equipment has been tested and found to comply with the limits for a Class B digital device, pursuant to part 15 of the FCC Rules. These limits are designed to provide reasonable protection against harmful interference in a residential installation.

You are cautioned that changes or modification not expressly approved by the party responsible for compliance could void your authority to operate the equipment.

This device complies with part 15 of the FCC Rules.

Operation is subject to the following two conditions:

1. This device may not cause harmful interference, and
2. This device must accept any interference received, including interference that may cause undesired operation.

LINDY Herstellergarantie – Hinweis für Kunden in Deutschland

LINDY gewährt für dieses Produkt über die gesetzliche Regelung in Deutschland hinaus eine zweijährige Herstellergarantie ab Kaufdatum. Die detaillierten Bedingungen dieser Garantie finden Sie auf der LINDY Website aufgelistet bei den AGBs.

Hersteller EU / EU Manufacturers

LINDY-Elektronik GmbH
Markircher Str. 20
DE-68229 Mannheim
GERMANY
T.: +49 (0)621 47005 0
info@lindy.de

LINDY Electronics Ltd.
Sadler Forster Way
Teesside Industrial Estate, Thornaby
Stockton-on-Tees, TS17 9JY
United Kingdom
T: +44 (0) 1642 754000
postmaster@lindy.co.uk

Recycling Information



WEEE (Waste of Electrical and Electronic Equipment), Recycling of Electronic Products

Europe, United Kingdom

In 2006 the European Union introduced regulations (WEEE) for the collection and recycling of all waste electrical and electronic equipment. It is no longer allowable to simply throw away electrical and electronic equipment. Instead, these products must enter the recycling process.

Each individual EU member state has implemented the WEEE regulations into national law in slightly different ways. Please follow your national law when you want to dispose of any electrical or electronic products. More details can be obtained from your national WEEE recycling agency.

Germany / Deutschland

Die Europäische Union hat mit der WEEE Direktive Regelungen für die Verschrottung und das Recycling von Elektro- und Elektronikprodukten geschaffen. Diese wurden im Elektro- und Elektronikgerätegesetz – ElektroG in deutsches Recht umgesetzt. Dieses Gesetz verbietet das Entsorgen von entsprechenden, auch alten, Elektro- und Elektronikgeräten über die Hausmülltonne! Diese Geräte müssen den lokalen Sammelsystemen bzw. örtlichen Sammelstellen zugeführt werden! Dort werden sie kostenlos entgegen genommen. Die Kosten für den weiteren Recyclingprozess übernimmt die Gesamtheit der Gerätehersteller.

France

En 2006, l'union Européenne a introduit la nouvelle réglementation (DEEE) pour le recyclage de tout équipement électrique et électronique.

Chaque Etat membre de l' Union Européenne a mis en application la nouvelle réglementation DEEE de manières légèrement différentes. Veuillez suivre le décret d'application correspondant à l'élimination des déchets électriques ou électroniques de votre pays.

Italy

Nel 2006 l'unione europea ha introdotto regolamentazioni (WEEE) per la raccolta e il riciclo di apparecchi elettrici ed elettronici. Non è più consentito semplicemente gettare queste apparecchiature, devono essere riciclate. Ogni stato membro dell' EU ha tramutato le direttive WEEE in leggi statali in varie misure. Fare riferimento alle leggi del proprio Stato quando si dispone di un apparecchio elettrico o elettronico.

Per ulteriori dettagli fare riferimento alla direttiva WEEE sul riciclaggio del proprio Stato.

LINDY No 38250, 38251, 38252, 38253, 38254, 38255, 38256, 38257, 38259



Tested to Comply with
FCC Standards
For Home and Office Use!

1st Edition, April 2015

www.lindy.com